

PARKING LOT SERIES

OUTDOOR

	15K	22K	27K	30K	45K
Potencia Nominal	100 W	150 W	180 W	200 W	300 W
Flujo Luminoso (lúmenes)	15,000	22,500	27,000	30,000	45,000
Tipo de Cuerpo	Cuerpo 1		Cuerpo 2		Cuerpo 3
Voltaje de Entrada AC	100-277				
Eficacia Luminosa (l/w)	150				
Distorsión Armónica	<10%				
Factor de Potencia	>0.93				
Frecuencia de Entrada	50-60 Hz				
Índice de Reproducción Cromática (IRC)	75				
Protección contra picos	10KV				
Material	Aluminio				
Color	Negra				
Óptica	Borosilicato				
Rango de Temperatura Ambiente	-30°C + 50°C				
Mantenimiento Lumínico (L70)	75,000 horas				
Temperatura de Color	3000K	4000K	5000K		
Montaje	Pared	Poste	Brazo		
Certificaciones	UL, DLC, CE, NOM, IP66, IK08				
Garantía	5 años				

FOTOCELDA

(opcional)

CUERPO 1



Dimensiones

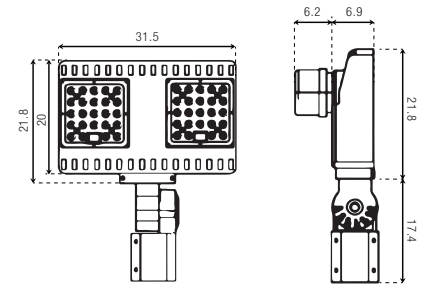

CUERPO 2

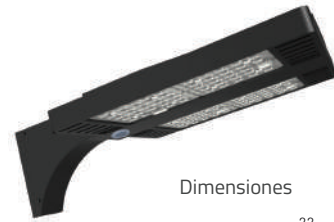

Dimensiones

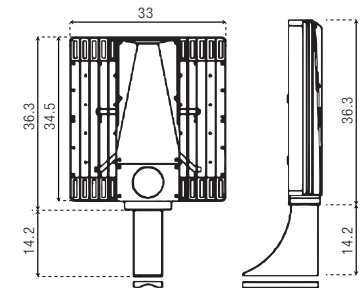

CUERPO 3



Dimensiones

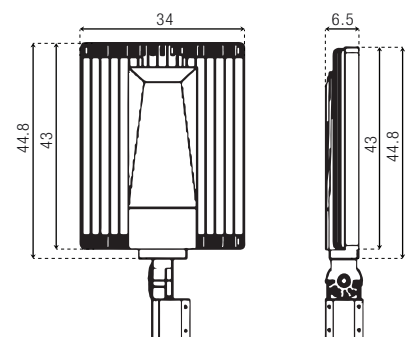

Ópticas

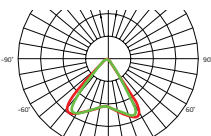

Tipo II

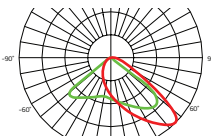

Tipo III

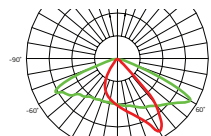

Tipo IV

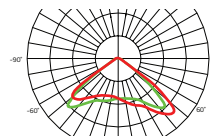

Tipo V

Montaje



Pared



Poste



Brazo

GUÍA DE COMPRA

Parking Lot Series

1 Serie	PL-	Parking Lot
2 Modelo	15K-	Parking Lot 100W
	22K-	Parking Lot 150W
	27K-	Parking Lot 180W
	30K-	Parking Lot 200W
	45K-	Parking Lot 300W
3 Temperatura de Color	30-	3000 K
	40-	4000 K
	50-	5000 K
4 Ángulo de apertura	1-	Tipo II
	2-	Tipo III
	3-	Tipo IV
	4-	Tipo V
5 Controles	N-	Ninguno
	P-	Fotocelda (On/Off)
	S-	Sensor (movimiento + aprovechamiento luz natural)
6 Montaje	1-	Montaje Pared
	2-	Montaje Poste
	3-	Montaje Brazo

EJEMPLO:

PL - 22K - 50 - 1 - P - 2
1 2 3 4 5 6



Datos Logísticos

15K

Código producto	PL-15K-XX-X-X-X
Dimensiones Producto (largo x ancho x alto)	20 cm x 31.5 cm x 6.5 cm
Peso Producto	3.9 kg
Empaque	Caja de Cartón
Dimensiones Empaque (largo x ancho x alto)	27 cm x 35.5 cm x 13 cm
Peso Producto	4.8 kg

22K / 27k / 30k

Código producto	PL-XX-XX-X-X-X
Dimensiones Producto (largo x ancho x alto)	34.5 cm x 33 cm x 6.5 cm
Peso Producto	5.9 kg
Empaque	Caja de Cartón
Dimensiones Empaque (largo x ancho x alto)	41.5 cm x 37 cm x 13 cm
Peso Producto	6.7 kg

45K

Código producto	PL-45K-XX-X-X-X
Dimensiones Producto (largo x ancho x alto)	43.5 cm x 34 cm x 6.5 cm
Peso Producto	9.5 kg
Empaque	Caja de Cartón
Dimensiones Empaque (largo x ancho x alto)	50.5 cm x 38 cm x 13 cm
Peso Producto	10.6 kg